

CENNÍK - uhlíková ocel'

platný od 1.10.2011

EUROTUBI
PRESSFITTING®
SYSTEM

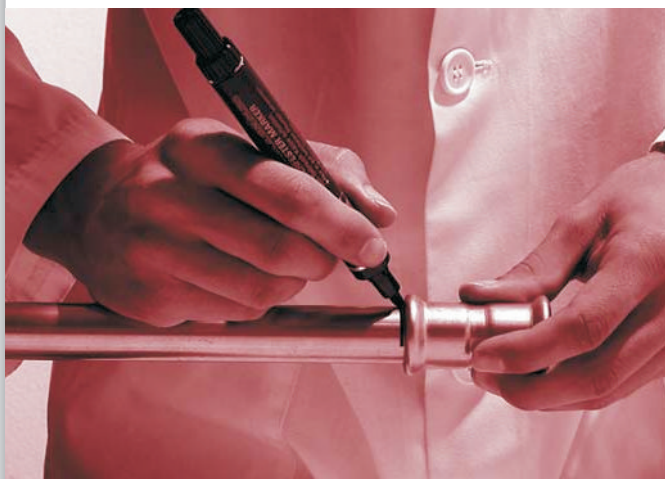

Tento cenník je platný od 1.10.2011.

Obsahuje doporučené maloobchodné ceny bez DPH a je určený na distribúciu pre všetkých našich obchodných partnerov.

Ceny uvedené v tomto cenníku môžu byť kedykoľvek zmenené z komerčných dôvodov. V prípade potreby si informáciu o platnosti cien uvedených v tomto cenníku overte u našich regionálnych obchodných manažérov.

Položky označené symbolom * nie sú štandardne držané sklados, dodávajú sa na objednávku. Ich prípadnú dostupnosť si overte u našich regionálnych obchodných manažérov.

Všetky ceny sú uvedené v € bez DPH!



Pre bližšie technické informácie si u vášho dodávateľa vyžiadajte **Technickú príručku** systému rozvodov z uhlíkovej ocele Eurotubi Pressfitting.

SPOJKA

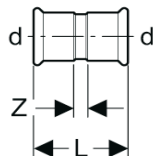

Kód	d	L	Z	Hmotnosť (g)	Cena (€/ks)	Maxipack (ks)
* C10AB	12	42	6	30	1,07	200
C10AC	15	52	10	36	1,09	200
C10AD	18	52	10	45	1,18	200
C10AE	22	59	13	60	1,32	200
C10AF	28	61	13	77	1,70	200
C10AG	35	72	18	103	2,69	120
C10AH	42	79	15	142	3,59	60
C10AJ	54	90	16	202	4,30	60
* C10AK	76,1	142	32	619	16,45	10
* C10AL	88,9	163	37	817	20,48	10
* C10AM	108	192	38	1 204	27,30	10

SPOJKA PREDĽŽENÁ

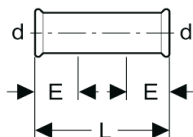

Kód	d	L	E	Hmotnosť (g)	Cena (€/ks)	Maxipack (ks)
* C11AB	12	56	22	40	1,24	200
* C11AC	15	75	24	51	1,26	200
* C11AD	18	77	25	60	1,41	100
* C11AE	22	86	27	81	1,55	100
* C11AF	28	92	28	112	1,93	100
* C11AG	35	99	31	136	3,77	100
* C11AH	42	119	35	203	4,49	60
* C11AJ	54	145	40	280	5,30	40
* C11AK	76,1	230	60	875	23,07	10
* C11AL	88,9	262	70	1 200	30,33	10
* C11AM	108	304	80	1 705	30,59	10

REDUKCIA MF

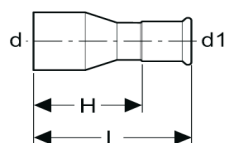

Kód	d - d1	L	H	Hmotnosť (g)	Cena (€/ks)	Maxipack (ks)
* C12CB	15-12	51	33	26	1,15	200
* C12DB	18-12	53	35	32	1,24	200
C12DC	18-15	55	34	36	1,57	200
* C12EB	22-12	60	42	39	1,13	200
C12EC	22-15	60	39	42	1,50	200
C12ED	22-18	57	36	44	1,53	200
* C12FB	28-12	75	57	55	2,14	160
C12FC	28-15	81	60	62	2,22	160
C12FD	28-18	84	63	68	2,27	160
C12FE	28-22	70	47	67	1,73	200
C12GC	35-15	84	63	84	3,24	60
C12GD	35-18	87	66	90	3,72	60
C12GE	35-22	76	53	95	2,53	160
C12GF	35-28	74	48	87	1,72	160
* C12HD	42-18	98	77	180	7,42	30
* C12HE	42-22	87	64	177	4,40	60
C12HF	42-28	100	76	128	4,38	60
C12HG	42-35	78	52	115	3,46	60
* C12JD	54-18	108	87	190	12,44	30
C12JE	54-22	110	88	185	11,07	30
* C12JF	54-28	100	76	185	11,11	40
* C12JG	54-35	129	102	206	7,62	40
C12JH	54-42	108	76	189	5,60	40
* C12KH	76,1-42	151	119	425	23,90	10
* C12KJ	76,1-54	145	108	454	24,08	10
* C12LJ	88,9-54	157	120	591	26,63	10
* C12LK	88,9-76,1	157	105	660	27,06	10
* C12MJ	108-54	204	167	880	34,61	10
* C12MK	108-76,1	196	144	948	34,82	10
* C12ML	108-88,9	192	133	962	41,12	10

KOLENO 90°

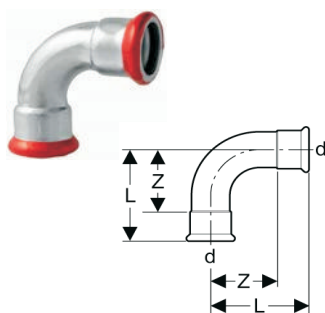

Kód	d	L	Z	Hmotnosť (g)	Cena (€/ks)	Maxipack (ks)
* C20ZB	12	42	24	40	1,61	200
C20ZC	15	41	20	47	1,68	200
C20ZD	18	45	24	58	1,86	200
C20ZE	22	49	26	78	2,12	200
C20ZF	28	59	35	112	2,90	120
C20ZG	35	72	45	175	5,69	120
C20ZH	42	91	59	246	9,50	60
C20ZJ	54	110	73	395	12,29	40
* C20ZK	76,1	150	95	977	29,45	10
* C20ZL	88,9	174	111	1 324	40,58	10
* C20ZM	108	215	138	1 991	57,47	10

KOLENO 90° MF

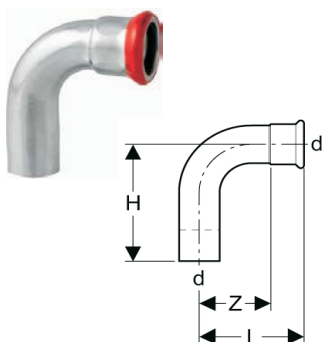

Kód	d	L	H	Z	Hmotnosť (g)	Cena (€/ks)	Maxipack (ks)
* C21ZB	12	42	48	24	35	1,69	200
C21ZC	15	41	49	20	47	1,75	200
C21ZD	18	45	53	24	58	1,93	200
C21ZE	22	49	59	26	80	2,18	200
C21ZF	28	59	69	35	113	2,89	100
C21ZG	35	72	83	45	175	5,92	100
C21ZH	42	91	96	59	250	9,53	40
* C21ZJ	54	110	116	73	392	12,50	40
* C21ZK	76,1	150	166	95	991	29,94	10
* C21ZL	88,9	174	190	111	1 329	42,29	10
* C21ZM	108	215	230	138	1 988	59,27	10

KOLENO 45°

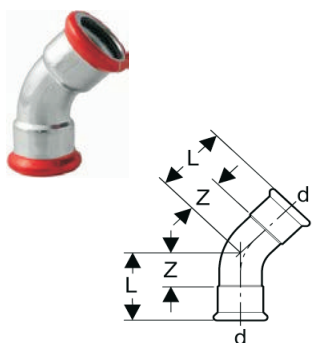

Kód	d	L	Z	Hmotnosť (g)	Cena (€/ks)	Maxipack (ks)
* C22ZB	12	32	14	34	1,81	200
C22ZC	15	30	9	39	1,92	200
C22ZD	18	31	10	47	2,04	200
C22ZE	22	35	12	63	2,17	200
C22ZF	28	41	17	90	2,98	100
C22ZG	35	56	29	150	5,46	100
* C22ZH	42	63	31	201	6,88	40
* C22ZJ	54	75	38	304	9,61	40
* C22ZK	76,1	98	43	800	28,69	10
* C22ZL	88,9	113	50	1 034	39,35	10
* C22ZM	108	138	61	1 550	53,63	10

KOLENO 45° MF

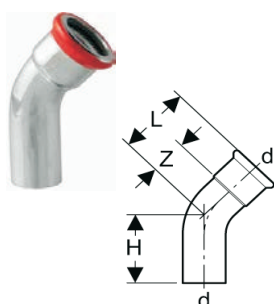

Kód	d	L	H	Z	Hmotnosť (g)	Cena (€/ks)	Maxipack (ks)
* C23ZB	12	32	41	14	32	1,80	200
C23ZC	15	30	42	9	39	1,90	200
C23ZD	18	31	35	10	47	1,95	200
C23ZE	22	35	47	12	66	2,11	200
C23ZF	28	41	47	17	90	2,94	100
C23ZG	35	36	66	29	153	5,37	100
C23ZH	42	63	70	31	202	6,96	40
* C23ZJ	54	75	82	38	316	9,78	40
* C23ZK	76,1	98	119	43	800	29,96	10
* C23ZL	88,9	113	130	50	1 054	39,97	10
* C23ZM	108	138	160	61	1 580	54,34	10

PRECHOD - vnútorný závit

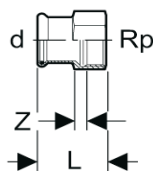

	Kód	d - Rp	L	Z	Hmotnosť (g)	Cena (€/ks)	Maxipack (ks)
*	C80PB	12-Rp ^{1/2}	35	5	45	3,79	200
*	C80NC	15-Rp ^{3/8}	35	4	65	3,82	200
	C80PC	15-Rp ^{1/2}	37	4	70	3,32	200
	C80PD	18-Rp ^{1/2}	37	4	57	3,39	200
	C80QD	18-Rp ^{3/4}	38	4	75	4,15	200
*	C80PE	22-Rp ^{1/2}	37	3	87	4,28	200
	C80QE	22-Rp ^{3/4}	40	4	80	4,22	200
	C80RE	22-Rp1	43	4	114	6,53	160
*	C80PF	28-Rp ^{1/2}	45	9	191	5,60	160
*	C80QF	28-Rp ^{3/4}	43	6	139	5,58	160
	C80RF	28-Rp1	45	5	119	5,14	160

PRECHOD - vonkajší závit

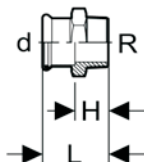

	Kód	d - R	L	H	Hmotnosť (g)	Cena (€/ks)	Maxipack (ks)
*	C81NB	12-R ^{3/8}	36	18	38	3,75	150
*	C81PB	12-R ^{1/2}	40	22	45	4,00	150
*	C81NC	15-R ^{3/8}	43	22	41	3,29	200
	C81PC	15-R ^{1/2}	43	22	55	3,53	200
	C81QC	15-R ^{3/4}	44	23	87	4,68	100
	C81PD	18-R ^{1/2}	44	23	65	3,61	200
	C81QD	18-R ^{3/4}	45	24	79	3,86	100
*	C81PE	22-R ^{1/2}	44	21	75	3,99	200
	C81QE	22-R ^{3/4}	45	22	95	3,91	200
	C81RE	22-R1	47	24	154	5,40	200
	C81QF	28-R ^{3/4}	47	23	101	6,40	200
	C81RF	28-R1	49	25	107	5,25	160
	C81SG	35-R1 ^{1/4}	54	27	169	7,58	100
*	C81TG	35-R1 ^{1/2}	54	27	172	7,91	100
	C81TH	42-R1 ^{1/2}	58	26	226	8,03	40
	C81VJ	54-R2	69	32	368	12,40	40
*	C81XK	76,1-R2 ^{1/2}	123	68	830	56,86	10
*	C81YL	88,9-R3	134	71	1 160	86,52	10
*	C81ZM	108-R4	156	78	2 005	113,71	10

PREDĽŽENIE - vnútorný závit

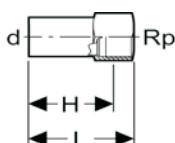

	Kód	d - Rp	L	H	Hmotnosť (g)	Cena (€/ks)	Maxipack (ks)
*	C86NB	12-Rp ^{3/8}	54	44	52	1,81	100
*	C86PB	12-Rp ^{1/2}	58	46	60	1,81	100
*	C86NC	15-Rp ^{3/8}	74	64	57	2,06	100
*	C86PC	15-Rp ^{1/2}	61	49	60	2,06	100
*	C86PD	18-Rp ^{1/2}	61	49	62	2,31	100
*	C86QD	18-Rp ^{3/4}	64	51	91	2,39	100
*	C86PE	22-Rp ^{1/2}	61	49	65	2,88	100
*	C86QE	22-Rp ^{3/4}	65	52	93	3,38	100

PREDĽŽENIE - vonkajší závit

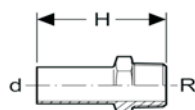

	Kód	d - R	H	Hmotnosť (g)	Cena (€/ks)	Maxipack (ks)
*	C87NB	12-R ^{3/8}	50	51	3,30	100
*	C87PB	12-R ^{1/2}	55	63	3,30	100
*	C87PC	15-R ^{1/2}	57	70	3,30	100
*	C87PD	18-R ^{1/2}	57	74	3,46	100
*	C87QD	18-R ^{3/4}	59	103	3,79	100
*	C87PE	22-R ^{1/2}	57	77	4,37	100
*	C87QE	22-R ^{3/4}	59	105	4,53	100

KOLENOVÝ PRECHOD 90° - vonkajší závit

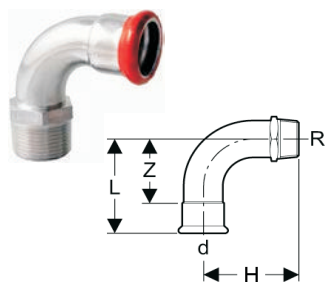

Kód	d - R	L	H	Z	Hmotnosť (g)	Cena (€/ks)	Maxipack (ks)
* C83NB	12-R ^{3/8}	42	34	24	49	4,37	40
* C83NC	15-R ^{3/8}	41	39	20	54	4,86	40
C83PC	15-R ^{1/2}	41	40	20	62	5,03	40
* C83PD	18-R ^{1/2}	45	48	24	73	5,27	40
* C83QE	22-R ^{3/4}	49	54	26	100	6,76	40
C83RF	28-R ¹	59	68	35	180	8,28	40
C83SG	35-R ^{1 1/4}	72	102	45	259	12,61	30
* C83TH	42-R ^{1 1/2}	91	116	59	375	20,52	30
* C83VJ	54-R ²	110	142	73	670	30,16	30

KOLENOVÝ PRECHOD 90° - vnútorný závit

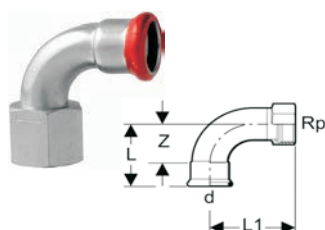

Kód	d - Rp	L	L1	Z	Hmotnosť (g)	Cena (€/ks)	Maxipack (ks)
* C82NB	12-Rp ^{3/8}	42	41	24	55	5,93	40
* C82NC	15-Rp ^{3/8}	41	44	20	60	6,26	40
C82PC	15-Rp ^{1/2}	41	44	20	74	6,67	40
C82PD	18-Rp ^{1/2}	45	51	24	84	7,09	40
C82QE	22-Rp ^{3/4}	49	56	26	119	8,49	40
* C82PF	28-Rp ^{1/2}	59	64	35	97	9,81	40

KOLENOVÝ PRECHOD KRÁTKY - vnútorný závit

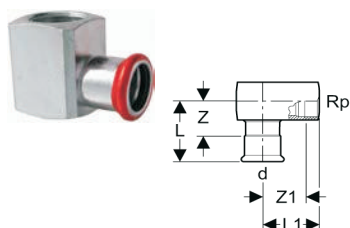

Kód	d - Rp	L	L1	Z	Z1	Hmotnosť (g)	Cena (€/ks)	Maxipack (ks)
* C30PC	15-Rp ^{1/2}	36	27	15	15	173	6,16	160
* C30PD	18-Rp ^{1/2}	36	27	15	15	169	6,47	120
* C30PE	22-Rp ^{1/2}	42	40	19	28	254	6,67	100
* C30QE	22-Rp ^{3/4}	42	30	19	17	285	6,89	100
* C30PF	28-Rp ^{1/2}	47	43	23	31	436	7,93	100

KOLENOVÝ PRECHOD KRÁTKY - vonkajší závit

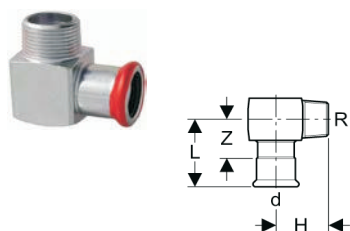

Kód	d - R	L	H	Z	Hmotnosť (g)	Cena (€/ks)	Maxipack (ks)
* C31NB	12-R ^{3/8}	34	21	16	73	4,37	150
* C31NC	15-R ^{3/8}	34	23	13	82	4,13	200
C31PC	15-R ^{1/2}	34	28	13	95	4,22	160
C31PD	18-R ^{1/2}	36	26	15	110	4,50	100
C31QD	18-R ^{3/4}	37	31	16	150	5,19	60
C31QE	22-R ^{3/4}	39	36	16	189	5,66	100

PRÍRUBOVÝ PRECHOD - PN6, PN10/16

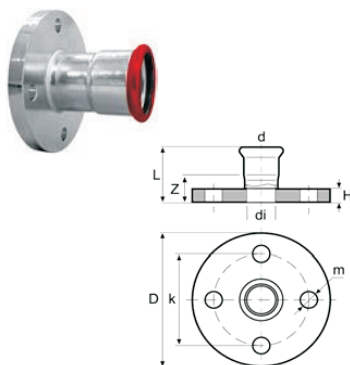

Kód	d	D	di	L	H	m	k	Z	Hmotnosť (g)	Cena (€/ks)	Maxipack (ks)
PN 10/16											
* C52AK	76,1	185	72	134	18	18	145	79	3 593	59,33	10
* C52AL	88,9	200	85	141	20	18	160	78	4 615	72,51	10
* C52AM	108	220	104	166	20	18	180	89	5 135	99,70	10
PN 6											
* C53AK	76,1	160	72	130	14	14	130	75	2 144	72,51	10
* C53AL	88,9	190	85	137	16	18	150	74	3 306	84,05	10
* C53AM	108	210	104	162	16	18	170	85	4 003	105,47	10

T - KUS

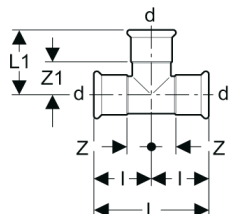

Kód	d	L	L1	Z	Z1	I	Hmotnosť (g)	Cena (€/ks)	Maxipack (ks)
* C40AB	12	56	35	10	17	28	48	3,46	200
C40AC	15	74	36	16	15	37	67	3,19	200
C40AD	18	80	37	19	16	40	82	3,44	200
C40AE	22	82	43	18	20	41	109	3,73	200
C40AF	28	92	46	22	22	46	144	4,80	160
C40AG	35	102	55	24	28	51	189	7,16	100
C40AH	42	118	60	27	28	59	270	10,63	40
C40AJ	54	142	73	34	36	71	396	12,77	40
* C40AK	76,1	232	121	61	66	116	1 150	51,21	10
* C40AL	88,9	262	126	68	63	131	1 600	58,78	10
* C40AM	108	312	152	79	75	156	2 319	76,54	10

T - KUS REDUKOVANÝ

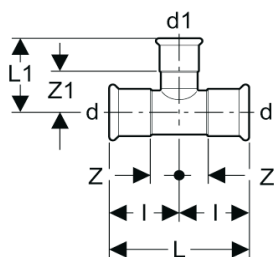

Kód	d - d1 - d	L	L1	Z	Z1	I	Hmotnosť (g)	Cena (€/ks)	Maxipack (ks)
* C41BC	15-12-15	74	33	16	15	37	63	3,87	100
* C41BD	18-12-18	80	34	19	16	40	74	4,12	100
C41CD	18-15-18	80	35	19	14	40	78	3,38	200
* C41BE	22-12-22	82	36	18	18	41	94	4,37	100
C41CE	22-15-22	82	40	18	19	41	98	3,53	200
C41DE	22-18-22	82	40	18	19	41	100	3,63	200
C41CF	28-15-28	92	42	22	21	46	126	4,60	160
C41DF	28-18-28	92	43	22	22	46	128	4,78	160
C41EF	28-22-28	92	46	22	23	46	135	5,20	160
C41CG	35-15-35	102	45	24	24	51	159	6,59	100
C41DG	35-18-35	102	45	24	24	51	160	7,05	100
C41EG	35-22-35	102	48	24	25	51	169	7,28	100
C41FG	35-28-35	102	50	24	25	51	178	7,40	100
* C41CH	42-15-42	118	52	27	31	59	224	10,88	60
* C41DH	42-18-42	118	52	27	31	59	228	10,96	60
C41EH	42-22-42	118	54	27	31	59	233	9,44	60
C41FH	42-28-42	118	53	27	29	59	239	9,72	60
C41GH	42-35-42	118	57	27	30	59	254	9,71	60
* C41CJ	54-15-54	142	54	34	33	71	349	13,43	40
* C41DJ	54-18-54	142	54	34	33	71	354	13,51	40
C41EJ	54-22-54	142	56	34	33	71	360	11,06	40
C41FJ	54-28-54	142	59	34	35	71	339	11,31	30
C41GJ	54-35-54	142	64	34	37	71	350	11,64	30
C41HJ	54-42-54	142	68	34	36	71	378	12,29	50
* C41EK	76,1-22-76,1	232	68	61	45	116	942	36,67	10
* C41FK	76,1-28-76,1	232	71	61	47	116	956	37,00	10
* C41GK	76,1-35-76,1	232	75	61	48	116	968	37,74	10
* C41HK	76,1-42-76,1	232	79	61	47	116	981	38,32	10
* C41JK	76,1-54-76,1	232	80	61	43	116	1 050	38,77	10
* C41EL	88,9-22-88,9	262	76	68	53	131	1 256	52,65	10
* C41FL	88,9-28-88,9	262	75,5	68	51,5	131	1 244	53,23	10
* C41GL	88,9-35-88,9	262	83	68	56,5	131	1 267	54,22	10
* C41HL	88,9-42-88,9	262	85	68	53	131	1 271	55,13	10
* C41JL	88,9-54-88,9	262	92,5	68	55,5	131	1 297	55,87	10
* C41KL	88,9-76,1-88,9	262	128	68	73	131	1 500	56,11	10
* C41EM	108-22-108	312	85	79	62	156	1 838	64,68	10
* C41FM	108-28-108	312	87,5	79	63,5	156	1 939	65,26	10
* C41GM	108-35-108	312	93,5	79	66	156	1 955	65,76	10
* C41HM	108-42-108	312	96	79	64	156	1 886	66,33	10
* C41JM	108-54-108	312	102	79	65	156	1 967	67,49	10
* C41KM	108-76,1-108	312	125,2	79	70,2	156	2 147	68,06	10
* C41LM	108-88,9-108	312	135	79	72	156	2 184	68,54	10

T - KUS PRECHODOVÝ - vnútorný závit

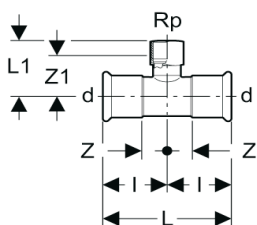

Kód	d - Rp - d	L	L1	Z	Z1	I	Hmotnosť (g)	Cena (€/ks)	Maxipack (ks)
* C42NB	12-Rp ^{3/8} -12	56	33	10	23	28	68	7,09	100
* C42PB	12-Rp ^{1/2} -12	56	36	10	23	28	75	7,09	100
C42PC	15-Rp ^{1/2} -15	74	38	16	23	37	82	4,47	200
C42PD	18-Rp ^{1/2} -18	80	39	20	24	40	95	4,49	160
C42PE	22-Rp ^{1/2} -22	82	42	18	30	41	113	4,74	200
C42QE	22-Rp ^{3/4} -22	82	43	18	30	41	120	6,51	100
C42PF	28-Rp ^{1/2} -28	92	44	22	32	46	140	5,41	160
C42QF	28-Rp ^{3/4} -28	92	45	22	32	46	159	6,64	100
C42PG	35-Rp ^{1/2} -35	102	48	24	36	51	176	7,19	100
C42QG	35-Rp ^{3/4} -35	102	48	24	35	51	191	9,18	100
* C42PH	42-Rp ^{1/2} -42	118	46	27	34	59	250	11,07	40
* C42QH	42-Rp ^{3/4} -42	118	51	27	38	59	255	12,84	40
* C42PJ	54-Rp ^{1/2} -54	142	58	34	46	74	333	13,01	30
* C42QJ	54-Rp ^{3/4} -54	142	59	34	46	74	350	13,53	30
* C42QK	76,1-Rp ^{3/4} -76,1	232	69	61	56	116	950	44,63	10
* C42QL	88,9-Rp ^{3/4} -88,9	262	76	68	63	131	1 240	60,28	10
* C42QM	108-Rp ^{3/4} -108	312	86	79	73	156	1 830	71,54	10

T - KUS REDUKOVANÝ - s dvoma redukovanými vývodmi

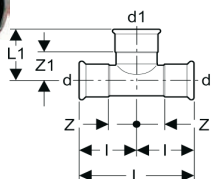

Kód	d - d1 - d	L	L1	Z	Z1	I	Hmotnosť (g)	Cena (€/ks)	Maxipack (ks)
* C44CB	12-15-12	56	38	10	17	28	52	3,79	100
C44DC	15-18-15	74	36	16	15	37	71	4,12	100
C44EC	15-22-15	74	42	16	19	37	84	4,49	100
C44ED	18-22-18	80	45	19	22	40	97	4,70	100
* C44FE	22-28-22	82	45	18	21	41	123	4,86	100

KRÍŽENIE 90°

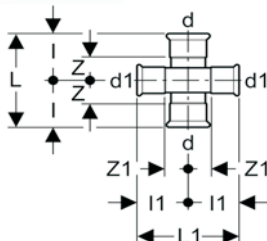

Kód	d - d1	L	L1	Z	Z1	I	I1	Hmotnosť (g)	Cena (€/ks)	Maxipack (ks)
* C45AC	15-15	74	74	16	16	37	37	100	9,78	100
C45CD	18-15	80	74	19	16	40	37	110	10,84	100
C45CE	22-15	82	74	18	16	41	37	130	11,41	100
* C45DE	22-18	82	80	18	19	41	40	140	11,58	100
* C45CF	28-15	92	74	22	16	46	37	156	12,09	50
* C45DF	28-18	92	80	22	19	46	40	166	12,26	50
* C45EF	28-22	92	82	22	18	46	41	186	13,03	50
* C45EG	35-22	102	82	24	18	51	41	218	19,15	50
* C45EH	42-22	118	82	27	18	59	41	280	24,83	40
* C45EJ	54-22	142	82	34	18	71	41	376	29,10	30

ZÁTKA

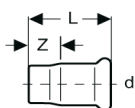

Kód	d	L	Z	Hmotnosť (g)	Cena (€/ks)	Maxipack (ks)
* C50AB	12	30	12	20	2,39	100
* C50AC	15	38	17	27	2,39	100
* C50AD	18	41	20	35	2,55	100
* C50AE	22	42	19	45	2,80	100
* C50AF	28	46	22	62	4,04	100
* C50AG	35	51	24	79	4,78	100
* C50AH	42	59	27	123	7,50	40
* C50AJ	54	73	36	179	8,16	40
* C50AK	76,1	95	40	361	15,33	10
* C50AL	88,9	115	52	495	19,13	10
* C50AM	108	130	53	707	27,63	10

ZÁVITOVÝ PRECHOD - vnútorný závit s tesnením

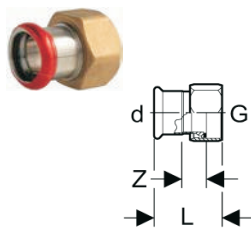

Kód	G - d	Tesnenie	L	Z	Hmotnosť (g)	Cena (€/ks)	Maxipack (ks)
* C60QC	G $\frac{3}{4}$ -15	EPDM	37	11	69	4,94	100
* C60QD	G $\frac{3}{4}$ -18	EPDM	39	11	70	5,11	100
* C60RE	G1-22	EPDM	40	11	84	5,60	100
* C60SF	G1 $\frac{1}{4}$ -28	EPDM	44	13	156	7,25	100
* C60TG	G1 $\frac{1}{2}$ -35	EPDM	48	13	194	11,95	40
* C60UH	G1 $\frac{3}{4}$ -42	EPDM	52	13	234	15,57	40
* C60WJ	G2-54	EPDM	58	15	405	18,46	40

PRECHODOVÉ ŠRÓBENIE - vnútorný závit

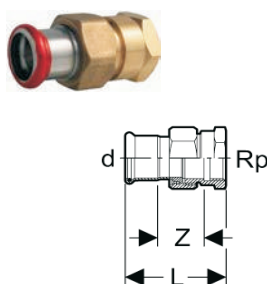

Kód	d - Rp	L	Z	Hmotnosť (g)	Cena (€/ks)	Maxipack (ks)
* C62PC	15-Rp $\frac{1}{2}$	59	26	188	7,09	30
* C62QC	15-Rp $\frac{3}{4}$	61	26	157	8,08	30
* C62PD	18-Rp $\frac{1}{2}$	59	26	190	8,08	30
* C62QD	18-Rp $\frac{3}{4}$	61	26	158	8,65	30
* C62QE	22-Rp $\frac{3}{4}$	63	27	184	9,48	30
* C62RE	22-Rp1	66	28	212	11,12	30
* C62RF	28-Rp1	71	31	388	14,42	30
* C62SG	35-Rp1 $\frac{1}{4}$	77	32	429	19,36	30
* C62TH	42-Rp1 $\frac{1}{2}$	82	33	509	35,10	30
* C62VJ	54-Rp2	95	37	872	50,76	30

PRECHODOVÉ ŠRÓBENIE - vonkajší závit

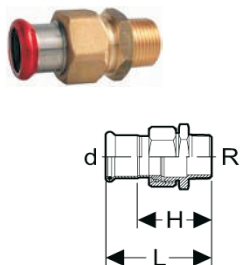

Kód	d - R	L	H	Hmotnosť (g)	Cena (€/ks)	Maxipack (ks)
* C64PC	15-R $\frac{1}{2}$	61	40	136	7,58	30
* C64QC	15-R $\frac{3}{4}$	63	42	124	8,65	30
* C64PD	18-R $\frac{1}{2}$	64	43	137	8,08	30
* C64QD	18-R $\frac{3}{4}$	66	45	125	8,90	30
* C64PE	22-R $\frac{1}{2}$	67	44	210	8,65	30
* C64QE	22-R $\frac{3}{4}$	68	45	195	9,23	30
* C64RE	22-R1	73	50	227	11,12	30
* C64RF	28-R1	75	51	384	12,77	30
* C64SG	35-R1 $\frac{1}{4}$	80	53	462	17,30	30
* C64TH	42-R1 $\frac{1}{2}$	85	53	560	26,37	30
* C64VJ	54-R2	97	60	863	56,03	30

POLNÁTRUBOK NA NALETOVANIE (bez galvanizácie)

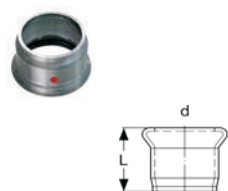

Kód	d	L	Hmotnosť (g)	Cena (€/ks)	Maxipack (ks)
* C17AB	12	23	12	0,74	400
* C17AC	15	25	17	0,82	400
* C17AD	18	25	21	0,91	400
* C17AE	22	27	29	0,99	400
* C17AF	28	30	36	1,28	300
* C17AG	35	34	50	2,02	300
* C17AH	42	38	65	2,72	200
* C17AJ	54	44	97	3,25	200
* C17AK	76,1	68	282	12,36	100
* C17AL	88,9	78	375	15,37	100
* C17AM	108	94	578	20,48	100

PRECHOD NA NALETOVANIE (bez galvanizácie)

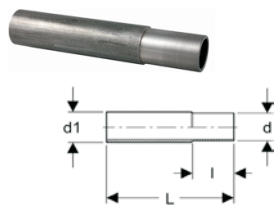

Kód	d-d1	L	I	Hmotnosť (g)	Cena (€/ks)	Maxipack (ks)
* C13AB	12-17	120	26	70	2,80	200
* C13AC	15-17	120	30	77	2,72	200
* C13AD	18-20	120	30	92	2,79	200
* C13AE	22-24	120	34	131	3,05	200
* C13AF	28-31	120	34	210	3,95	200
* C13AG	35-38	120	40	255	4,62	150
* C13AH	42-44,5	120	45	307	5,51	100
* C13AJ	54-57	120	50	375	6,76	100

NADOBLÚK

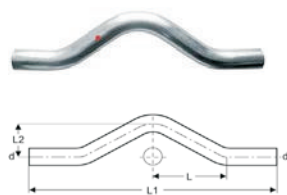

Kód	d	L1	L2	L	Hmotnosť (g)	Cena (€/ks)	Maxipack (ks)
* C76AB	12	200	35	55	90	3,38	30
C76AC	15	202	37	64	110	3,55	30
C76AD	18	237	42	66	155	3,76	30
C76AE	22	233	42	58	159	4,03	20
* C76AF	28	301	50	102	335	4,71	20

NADOBLÚK KRÁTKY

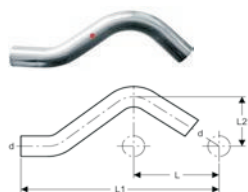

Kód	d	L1	L2	L	Hmotnosť (g)	Cena (€/ks)	Maxipack (ks)
* C77AB	12	154	35	55	60	1,98	20
C77AC	15	145	37	57	80	1,98	20
C77AD	18	157	40	60	106	2,14	20
C77AE	22	175	52	65	147	2,43	20
C77AF	28	226	65	74	249	2,90	20

RÚRKA 90°

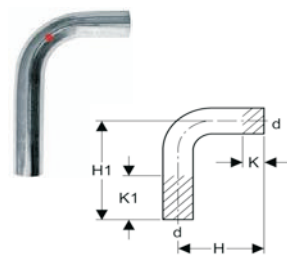

Kód	d	H1	H	K	K1	Hmotnosť (g)	Cena (€/ks)	Maxipack (ks)
* C70AB	12	120	70	17	67	72	1,32	80
C70AC	15	120	70	22	72	88	1,46	80
C70AD	18	120	70	17	67	103	1,58	80
C70AE	22	120	70	9	59	132	1,66	40
* C70AF	28	125	97	7	47	190	1,94	40
* C70AG	35	201	121	62	62	359	4,28	20
* C70AH	42	254	160	90	90	553	6,65	20
* C70AJ	54	302	202	45	45	877	8,93	20
* C70AK	76,1	250	250	62	60	1 752	60,15	10
* C70AL	88,9	291	291	90	90	2 532	71,69	10
* C70AM	108	364	364	45	45	3 604	92,70	10

KRÍŽENIE JEDNOSTRANNÉ

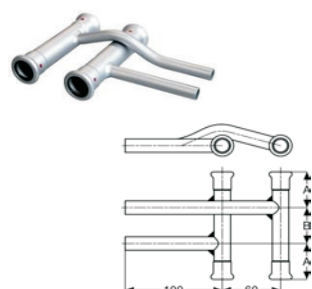

Kód	d1-d2	A	B	Hmotnosť (g)	Cena (€/ks)	Maxipack (ks)
* C91CC	15-15	40	40	250	20,19	20
* C91BD	18-12	40	40	270	20,52	20
* C91CD	18-15	40	40	280	21,09	20
* C91BE	22-12	40	40	300	21,75	20
* C91CE	22-15	40	40	320	22,91	20
* C91BF	28-12	40	40	430	23,40	20
* C91CF	28-15	40	40	450	23,73	20

KRÍŽENIE OBOJSTRANNÉ

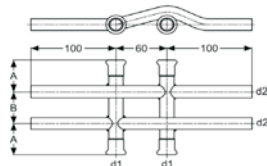

	Kód	d1-d2	A	B	Hmotnosť (g)	Cena (€/ks)	Maxipack (ks)
*	C90BB	12-12	30	40	305	26,86	20
*	C90BC	15-12	40	40	330	29,50	20
*	C90CC	15-15	40	40	355	29,99	20
*	C90BD	18-12	40	40	370	31,48	20
*	C90CD	18-15	40	40	380	32,05	20
*	C90CE	22-15	40	40	420	32,80	20
*	C90BF	28-12	40	40	530	34,11	20
*	C90CF	28-15	40	40	560	35,27	20
*	C90CG	35-15	40	40	660	39,39	20

O-krúžok EPDM (čierny)

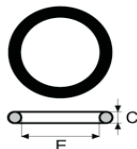

	Kód	d	E	C	Hmotnosť (g)	Cena (€/ks)	Maxipack (ks)
*	000719	12	12	2,4	0,3	0,14	150
*	000720	15	15	2,6	0,3	0,15	150
*	000721	18	18	2,6	0,4	0,19	150
*	000722	22	22	3,2	0,7	0,21	150
*	000723	28	28	3,1	0,8	0,23	150
*	000724	35	35	3,1	1,0	0,25	100
*	000725	42	42	4,1	2,2	0,38	100
*	000726	54	54	4,1	2,8	0,44	100
*	000727	76,1	76,1	8,0	11,5	0,92	50
*	000728	88,9	88,9	8,2	17,5	1,23	50
*	000729	108	108	11,0	33,8	2,42	50

O-krúžok VITON (zelený)

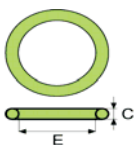

	Kód	d	E	C	Hmotnosť (g)	Cena (€/ks)	Maxipack (ks)
*	002485	12	12	2,4	0,3	0,44	100
	002849	15	15	2,6	0,3	0,46	100
	002850	18	18	2,6	0,4	0,54	100
	002851	22	22	3,2	0,7	0,59	100
	002852	28	28	3,1	0,8	0,72	100
	002853	35	35	3,1	1,0	0,99	50
	002854	42	42	4,1	2,2	1,60	50
	002855	54	54	4,1	2,8	1,73	50
*	002983	76,1	76,1	8,0	11,5	2,46	20
*	002984	88,9	88,9	8,2	17,5	3,68	20
*	002985	108	108	11,0	33,8	6,76	20

RÚRKA - vonkajšie zinkovanie za tepla



	Kód	Ø vonkajší [mm]	Hrúbka steny (mm)	Dĺžka (m)	Hmotnosť (kg/m)	Cena (€/m)
*	TUCZ012-6	12	1	6	0,319	1,60
	TUCZ015-6	15	1,2	6	0,408	1,70
	TUCZ018-6	18	1,2	6	0,497	1,80
	TUCZ022-6	22	1,5	6	0,758	2,50
	TUCZ028-6	28	1,5	6	0,980	3,10
	TUCZ035-6	35	1,5	6	1,239	4,00
	TUCZ042-6	42	1,5	6	1,498	4,60
	TUCZ054-6	54	1,5	6	1,942	6,40
*	TUCZ076-6	76,1	2	6	3,655	13,10
*	TUCZ088-6	88,9	2	6	4,286	14,80
*	TUCZ108-6	108	2	6	5,228	22,80

Stiahnite si **Technickú príručku** i **Cenník** v elektronickej forme
na stránke:
www.giacomini.sk

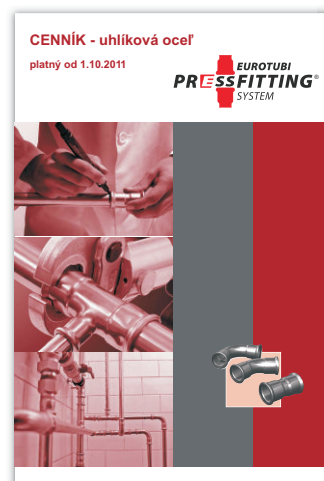
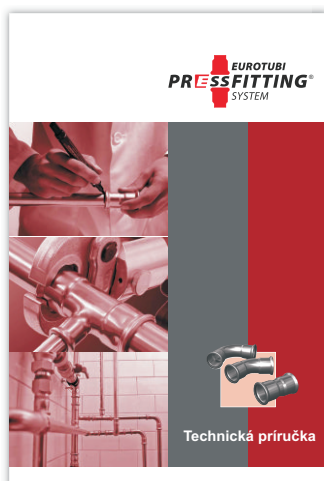

importér pre Slovenskú republiku:

Domtech Giacomini s.r.o.
Dolné Rudiny 1, 010 91 Žilina
E-mail: obchod@giacomini.sk
Http: www.giacomini.sk



výrobca:

EUROTUBI EUROPA SRL

Via Croce Rossa Italiana, 12
20054 NOVA MILANESE (MI) - Italy
E-mail: info@eurotubieuropa.it
Http: www.eurotubieuropa.it